



NORWESCO VALVES

std = standard port	fp = full port	Fimco Code No.	Mfg. Part No.	Size	List Price
 <p>POLY BOLTED BALL VALVE STAINLESS STEEL BOLTS, NUTS & WASHERS</p>		5143361	60540	1/2" fp	\$25.65
		5143362	60541	3/4" fp	\$25.65
		5143363	60542	1" std	\$25.65
		5143364	60543	1" fp	\$29.90
		5143365	61734	1-1/4" std	\$29.90
		5143366	60527	1-1/4" fp	\$38.22
		5143367	60526	1-1/2" fp	\$38.22
		5143368	60529	2" std	\$37.10
		5143369	60528	2" fp	\$54.19
		5143370	61720	3" fp	\$130.64
	5143396	62787	4" fp	\$262.89	
<p>POLY BOLTED BALL VALVE WITH MALE NIPPLE</p> 		5143371	62046	2" std	\$37.10
		5143372	61876	2" fp	\$56.77
		5143373	62047	3" fp	\$130.64
<p>ANGLE VALVE</p> 		5143374	60544	1-1/2" fp	\$52.26
		5143375	60545	2" std	\$53.86
		5143376	60546	2" fp	\$73.54
<p>SINGLE UNION BALL VALVE</p> 		5143205	60409	1/2"	\$10.81
		5143206	60410	3/4"	\$11.76
		5143207	60411	1"	\$15.01
		5143208	60412	1-1/4"	\$25.03
		5143209	60413	1-1/2"	\$30.54
		5143210	60414	2"	\$39.17
		5143377	60415	3"	\$115.94
		5143378	60479	1"/45° Nozzle Valve	\$15.64
<p>MULTI-PORT BALL VALVE</p> 		5143379	60417	3/4" True Union	\$34.31
		5143380	60418	2" Multi-Port	\$48.57
<p>POLY COMPACT BALL VALVE STAINLESS STEEL BOLTS, NUTS & WASHERS</p> 		5143381	62286	2" fp/mpt x fpt	\$42.73
		5143382	62287	2" fp/fpt x fpt	\$42.73
		5143383	62288	2" fp/mpt x male Coupler	\$42.73
		5143384	62314	2" fp/fpt x male Coupler	\$42.73

VALVES

VALVES

		Fimco Code No.	Mfg. Part No.	Description	List Price
		CELCON GLOBE VALVE - FIPT	5143107	SCL-0500T	1/2"
		5143123	SCL-0750T	3/4"	\$8.54

		Fimco Code No.	Mfg. Part No.	Description	List Price
		POLY NOZZLE (BALL) VALVE	5143140	VA150	1-1/2"
		5143141	VA200	2"	\$60.49

		Fimco Code No.	Mfg. Part No.	Description	List Price
		POLY BALL VALVE	5143220	V075	3/4"
		5143144	V100	1"	\$35.45
		5143173	V125	1-1/4"	\$39.09
		5143142	V150	1-1/2"	\$50.24
		5143143	V200	2"	\$50.24
		5143161	V300	3"	\$113.90

		Fimco Code No.	Mfg. Part No.	Description	List Price
		FULL PORT POLY BALL VALVE	5143221	V100FP	1"
		5143222	V200FP	2"	\$70.75
		5143223	V300FP	3"	\$169.08

		Fimco Code No.	Mfg. Part No.	Description	List Price
		UNION (BALL) VALVE	5143205	60409	1/2"
		5143206	60410	3/4"	\$11.76
		5143207	60411	1"	\$15.01
		5143208	60412	1-1/4"	\$25.03
		5143209	60413	1-1/2"	\$30.54
		5143210	60414	2"	\$39.17
		5143377	60415	3"	\$115.94
		5143378	60479	1" 45° Nozzle Valve	\$15.64

VALVES & MANIFOLDS

POLY MANIFOLD	Fimco Code No.	Mfg. Part No.	Description	Port Size		List Price
				Inlet	Outlet	
	5143358	TMO75/050	Poly Manifold	(1)3/4"	(8)1/2" -1/4"	\$29.13

BRASS BALL VALVE	Fimco Code No.	Mfg. Part No.	Description	List Price
	5143211	101-302	3/8"	\$11.22
	5143197	101-303	1/2"	\$9.74
	5143190	101-304	3/4"	\$13.26
	5143191	101-305	1"	\$20.58

ALUMINUM MANIFOLD BY-PASS VALVE	Fimco Code No.	Mfg. Part No.	Description	Port Size		List Price
				Inlet	Outlet	
	5143066	2142-2	Aluminum Manifold-By-Pass 0-600 PSI	(1)1/2"	(3)3/8" (1)1/4"	\$46.09

HAMILTON NYLON REGULATOR VALVE	Fimco Code No.	Mfg. Part No.	Description	Port Size		List Price
				Inlet	Outlet	
	5143336	2064-05-58	Nylon Pressure Relief Valve	(1)1/2"	(1) 3/4"	\$15.00
	5143337	2066-05-58	Nylon Pressure Relief Valve	(1)3/4"	(1) 3/4"	\$15.00

DIAPHRAGM TYPE PRESSURE RELIEF/REGULATING VALVE



5271298	8460-1/2 w/ 1/2" NPT Connections	Nylon Valve	\$62.45
5271299	8460-3/4 w/ 3/4" NPT Connections	Nylon Valve	\$62.45

Bypasses excess liquid. Choice of 1/2" and 3/4" NPT sizes. Chemical resistant diaphragm seals off operating parts from contact with chemicals remains resilient for chatter-free, responsive pressure control.

Nylon inlet body with aluminum bonnet. Choice of 1/2" or 3/4" NPT (M) inlet and (F) outlet connections. Flow rates to 56 GPM for 1/2" size and to 70 GPM for 3/4" size.

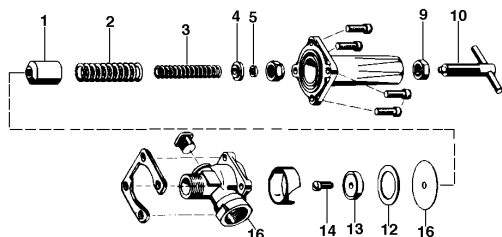

Ref. No.	Fimco Code No.	Mfg. Part No.	Description	List Price
1	5124023	CP8367-AL	Guide Sleeve	\$7.41
*2	Available In Kit Only		Outside Spring	
*3	Available In Kit Only		Inside Spring	
4	5108026	CP8371-AL	Spring Retainer	\$3.98
*5	Available In Kit Only		Washer, Nylon	
9	5006073	CP5898-AL	Lock Nut	\$1.76
10	5271372	CP5896-AL SS	Adjusting Stem	\$8.27
*11	Available In Kit Only		Diaphragm	
12	5110079	CP8365-304SS	Stop Ring	\$4.50
*13	Available In Kit Only		Seat, Nylon	
14	5117091	CP8477-IZP	Screw	\$1.46
16	5002244	CP8361-1/2 NYB	Body, Nylon 1/2"	\$14.48
16	5002245	CP8361-3/4 NYB	Body, Nylon 3/4"	\$14.48
*	5168186	PK-AB8460-KIT	Repair Parts Kit-Marked w/*	\$22.52

VALVES

VALVES

SPRAYING SYSTEMS NO. 17 SELECTOR TEE VALVE

Choice of 7 Indexed Spray Boom Settings

Side Connection for by-pass and pressure relief valve



Spraying Systems Co.®

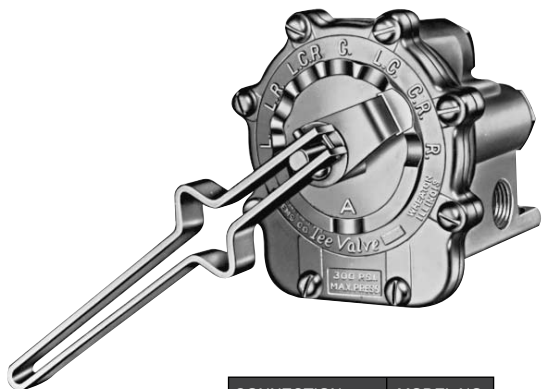

Side Connection for spray gun

CONNECTION	MODEL NO.
Inlet Conn, 3/4" NPT	17L
Inlet Conn. 1" NPT	17Y
Boom Outlets (3)	3/4" NPT
GunJet Outlet	
Accessory Outlets	3/4" NPT

TeeValve remains shut off during selection of setting,

Lever is raised to open valve in indexed setting is lowered to close valve without changing index position. Gives fast positive "on-off" operation at ends of crop rows.

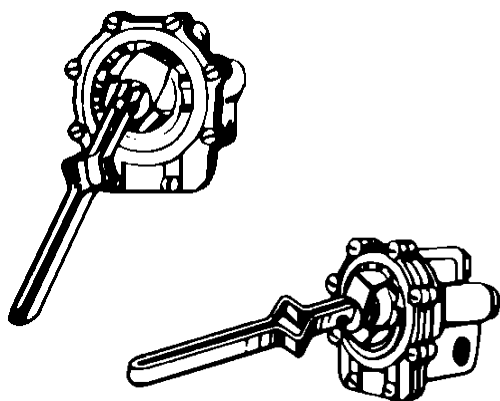

5143295	AA17-L	3/4" FNPT Boom & 3/4" Valve & Gun Outlets	\$127.60
5143298	AA17-Y	3/4" FNPT Boom & 1" & 3/4" Valve & Gun Outlets	\$127.60

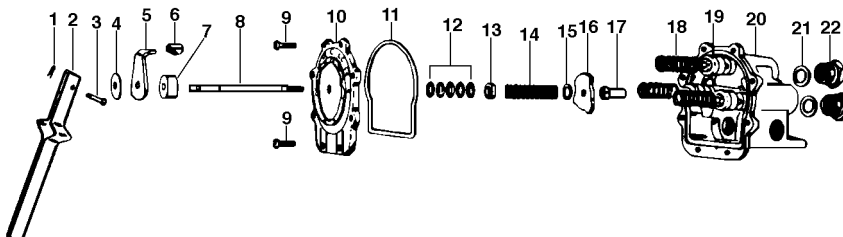

Ref. No.	Fimco Code No.	Mfg. Part No.	Description	List Price
* 1	Available In Kit Only		1/16" x 1/2" SS Cotter Pin	
2	5078065	CP6849-1-IZP	Handle	\$9.00
* 3	Available In Kit Only		Rivet	
* 4	Available In Kit Only		Handle Washer	
5	5120011	CP12128-IZP	Selector Shield	\$5.93
* 6	Available In Kit Only		Selector Shield Tip, Celcon	
7	5127032	CP12129-CE	Spacer, Celcon	\$5.28
8	5132010	CP6972-SS	Main Stem, stainless steel	\$10.61
* 9	Available In Kit Only		Hex Head Screw, 1/4-20 x 3/4"	
10	5017090	CP12126-AL	CoverPlate, Alum.	\$49.80
*11	Available In Kit Only		Gasket, Buna N	
*12	Available In Kit Only		Packing, Thermo Leather, (5 Reqd)	
13	5097032	CP12130-SS	Packing Gland, Stainless Steel	\$7.60
14	5019059	CP7254-SS	Main Spring, Stainless Steel	\$3.80
15	5016062	CP7987-SS	Washer, Stainles Steel	\$1.50
16	5045008	CP6971-AL	Selector Cam, Alum	\$4.28
17	5006068	CP6973-SS	Guide Nut	\$5.33
18	5019057	CP6959-SS	Spring, Stainless steel (3 Reqd)	\$3.20
19	5132021	CP6956-CE	Valve Stem, Celcon (3 Reqd.)	\$3.95
20	5002253	CP6934-3/4-AL	Body, Aluminum	\$58.01
*21	Available In Kit Only		Seat Plate, Poly (3 Reqd.)	
22	5005095	CP7902-AL	Outlet Adapter (3 Reqd.)	\$9.64
23	5005259	CP50116-AL	Inlet Adapter 1" M x 3/4"F (for17L)	\$7.43
	5168135	PK-AB17-KIT	Repair Parts Kit Items Marked*	\$35.40

VALVES

TEEJET VARI-SPACING NOZZLES

- For use with all interchangeable Spray Tips
- For operating pressures up to 125 p.s.i.

TeeJet Vari-Spacing Nozzles permit the construction of spray booms with adjustable nozzle spacing. Pipe, round tubing or square tubing is used to support the nozzles and nozzles are hose connected for liquid flow. A complete TeeJet Vari-Spacing Nozzle consists of clamp, lock nut, TeeJet Vari-Spacing body, TeeJet cap, internal strainer and Spray Tip of

your choice TeeJet, FloodJet or ConeJet. Nozzle bodies are made in a selection of materials brass, nylon and Celcon, with clamps made of heavy duty zinc-plated steel for rigid mounting. Choice of clamp sizes to fit 1/2", 3/4", 1" and 1-1/4" pipe or equivalent size tubing and 1", 1-1/4", & 1-1/2" Square tubing.

	Fimco Code No.	Mfg. Part No.	Description	List Price
	5056094	3NTL38	Poly L Connector less cap & tip, fits 3/8" hose	\$1.46
5056024	NTL38	Nylon L Connector less cap & tip, fits 3/8" hose	\$1.54	
5056095	3NTL12	Poly L Connector less cap & tip, fits 1/2" hose	\$1.46	
5056023	NTL12	Nylon L Connector less cap & tip, fits 1/2" hose	\$1.54	
5056096	3NTL58	Poly L Connector less cap & tip, fits 5/8" hose	\$1.85	
5056061	NTL58	Nylon L Connector less cap & tip, fits 5/8" hose	\$1.93	
5056097	3NTL34	Poly L Connector less cap & tip, fits 3/4" hose	\$2.00	
5056057	NTL34	Nylon L Connector less cap & tip, fits 3/4" hose	\$1.78	
5056014	6471B-400TD	Brass L Connector less cap & tip, fits 3/8" hose	\$12.34	
5056007	9191B-531TD	Brass L Connector less cap & tip, fits 1/2" hose	\$12.34	

	Fimco Code No.	Mfg. Part No.	Description	List Price
	5056098	3NTT38	Poly T Connector less cap & tip, Fits 3/8" hose	\$1.63
5056028	NTT38	Nylon T Connector less cap & tip, fits 3/8" hose	\$1.58	
5056099	3NTT12	Poly T Connector less cap & tip, fits 1/2" hose	\$1.63	
5056027	NTT12	Nylon T Connector less cap & tip, fits 1/2" hose	\$1.63	
5056100	3NTT58	Poly T Connector less cap & tip, fits 5/8" hose	\$2.55	
5056062	NTT58	Nylon T Connector less cap & tip, fits 5/8" hose	\$2.00	
5056101	3NTT34	Poly T Connector less cap & tip, fits 3/4" hose	\$2.16	
5056056	NTT34	Nylon T Connector less cap & tip, fits 3/4" hose	\$2.54	
5056015	6472B-400TD	Brass T Connector less cap & tip, fits 3/8" hose	\$12.34	
5056008	9192B-531TD	Brass T Connector less cap & tip, fits 1/2" hose	\$12.34	

	Fimco Code No.	Mfg. Part No.	Description	List Price
	5272127	T-38C	Nylon Cross Connector less cap & tip, fits 3/8" hose	\$3.54
5271920	T-12C	Nylon Cross Connector less cap & tip, fits 1/2" hose	\$3.62	

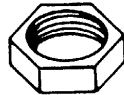
	Fimco Code No.	Mfg. Part No.	Description	List Price
	5006087	CP5609	Brass lock nut	\$2.51
5006184	B-12	Nylon lock nut	\$.30	

	Fimco Code No.	Mfg. Part No.	Description	List Price
	5271963	AA111-1/2	Upper & Lower Clamp & Screw	\$4.44
5271964	AA111-3/4	Upper & Lower Clamp & Screw	\$4.44	
5271965	AA111-1	Upper & Lower Clamp & Screw	\$4.44	
5272510	AA111-1 1/4	Upper & Lower Clamp & Screw	\$7.44	

VARI-SPACING NOZZLES & DIAPHRAGM CHECK VALVES

	Fimco Code No.	Mfg. Part No.	Description	List Price
	5271966	AA111SQ-1	Upper & Lower Clamp & Screw	\$5.10
	5271933	AA111SQ-1-1/4	Upper & Lower Clamp & Screw	\$7.68
	5272511	AA111SQ-1-1/2	Upper & Lower Clamp & Screw	\$9.14

DIAPHRAGM CHECK VALVES

 <p>TYPE 8360</p>	Made of Nylon with Celcon / polypropylene end cap assembly. Check valve opens at 10 P.S.I. pressure. 1/4" NPT(M) inlet connection. For flow rates up to 2 G.P.M. Overall length 2". Weight 1 ounce.			
	Fimco Code No.	Mfg. Part No.	Description	List Price
	5138473	8360-NYB	Check Valve Less Cap, Tip & Strainer	\$16.15
	5005137	4676-NYB-1/4	1/4" Nylon Adapter	\$2.23

 <p>TYPE 13430</p>	Nylon with polypropylene retainer ring. Single, double or triple hose connection for 3/8" or 1/2" hose I.D. For flow rates to 3 G.P.M.			
	Fimco Code No.	Mfg. Part No.	Description	List Price
	5056054	13430-1L-406-NYB	L Valve, fits 3/8 I.D. Hose	\$20.87
	5056060	13430-1R-406-NYB	L Valve, fits 3/8 I.D. Hose	\$20.87
	5056053	13430-1L-540-NYB	L Valve, fits 1/2 I.D. Hose	\$20.87
	5056049	13430-1R-540-NYB	L Valve, fits 1/2 I.D. Hose	\$20.87
	5056055	13430-2-406-NYB	T Valve, fits 3/8 I.D. Hose	\$20.87
	5056048	13430-2-540-NYB	T Valve, fits 1/2 I.D. Hose	\$20.87
	5056077	13430-3-406-NYB	Cross Valve, fits 3/8 I.D. Hose	\$20.87
	5056078	13430-3-540-NYB	Cross Valve, fits 1/2 I.D. Hose	\$20.87

<p>REPAIR PARTS FOR DIAPHRAGM CHECK VALVES</p>  <p>4620 Diaphragm</p>	5063083	CP4620-FA	Diaphragm, Fairprene	\$.42
	5063119	CP6227-TEF	Diaph., Teflon, use w/4620FA or 21953	\$.72
	5063084	CP4620-VI	Diaphragm, Viton	\$1.46
	5046113	21950-10-NYB	Chemsaver End-Cap Sub-Asb.,	\$3.51
	5063132	CP21953-EPR	Diaphragm, EPDM rubber w/Nipples	\$.42
	5063133	CP21953-VI	Diaphragm, Viton w/Nipples	\$1.42

NOZZLES

"QUICKJET" NOZZLE ASSEMBLY SYSTEM



*Order items individually to make assemblies

When your operation calls for different size spray tips, or when strainers need cleaning, time is important. The longer you shut down the more it costs you.



THE NEW "QUICKJET" WAY PROVIDES

1. Quick "off-on" of tip and cap assembly.
2. Automatic self alignment of flat spray patterns.

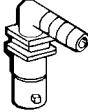
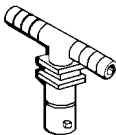
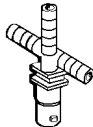
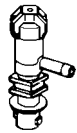
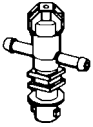
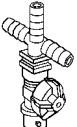
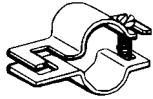
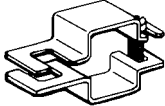

	Fimco Code No.	Mfg. Part No.	Description	List Price
	5056065	18638-111-540-NYB	Single 1/2" Hose Shank Quick Teejet Nozzle Body	\$3.92
	5056066	18719-111-785-NYB	Single 3/4" Hose Shank Quick Teejet Nozzle Body	\$3.92
	Fimco Code No.	Mfg. Part No.	Description	List Price
	5056067	18639-112-540-NYB	Double 1/2" Hose Shank Quick Teejet Nozzle Body	\$3.92
	5056068	18720-112-785-NYB	Double 3/4" Hose Shank Quick Teejet Nozzle Body	\$3.92
	Fimco Code No.	Mfg. Part No.	Description	List Price
	5056069	18640-113-540-NYB	Triple 1/2" Hose Shank Quick Teejet Nozzle Body	\$3.92
	5056070	18721-113-785-NYB	Triple 3/4" Hose Shank Quick Teejet Nozzle Body	\$3.92
	Fimco Code No.	Mfg. Part No.	Description	List Price
	5056086	22251-311-500-NYB	Single 1/2" Hose Shank w/Diaphragm Check Valve	\$8.27
	5056087	22251-311-750-NYB	Single 3/4" Hose Shank w/Diaphragm Check Valve	\$8.27
	Fimco Code No.	Mfg. Part No.	Description	List Price
	5056089	22252-312-500-NYB	Double 1/2" Hose Shank w/Diaphragm Check Valve	\$8.27
	5056090	22252-312-750-NYB	Double 3/4" Hose Shank w/Diaphragm Check Valve	\$8.27
	Fimco Code No.	Mfg. Part No.	Description	List Price
	5056075	19351-213-540-NYB	Triple 1/2" Hose Shank w/Diaphragm Check Valve	\$10.01
	5056076	19351-213-785-NYB	Triple 3/4" Hose Shank w/Diaphragm Check Valve	\$10.01
	Fimco Code No.	Mfg. Part No.	Description	List Price
	5272162	QJ111-3/4	Quick Teejet Clamp Sub Assy for 3/4" Pipe	\$2.57
	5272163	QJ111-1	Quick Teejet Clamp Sub Assy for 1" Pipe	\$2.57
	Fimco Code No.	Mfg. Part No.	Description	List Price
	5272164	QJ111SQ-1	Quick Teejet Clamp Sub Assy for 1" Sq Tube	\$2.57
	5272165	QJ111SQ-1-1/4	Quick Teejet Clamp Sub Assy for 1 1/4" Sq Tube	\$2.57



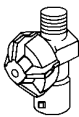

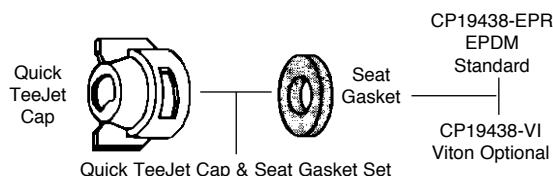

“QUICKJET” NOZZLE ASSEMBLY SYSTEM

	Fimco Code No.	Mfg. Part No.	Description	List Price
	5002375	QJT-NYB	Quick Teejet Adapter w/ Gasket Fits Teejet Nozzle Bodies	\$4.99
	Fimco Code No.	Mfg. Part No.	Description	List Price
	5072308	CP20266-EPDM	Gasket For QJT-NYB & QJT8360-NYB Adapter	\$1.77
	Fimco Code No.	Mfg. Part No.	Description	List Price
	5002376	QJT8360-NYB	Same as QJT-NYB w/Diaphragm Check Valve	\$6.47
	Fimco Code No.	Mfg. Part No.	Description	List Price
	5002380	QJ8360-NYB	Diaphragm Ck. Valve Quick Teejet Nozzle Body Assy.	\$6.89

QUICK TEEJET CAPS

The Quick TeeJet Caps are designed with grooves that fit locating lugs on the nozzle body. Caps are made of Celcon and are available for use with all TeeJet spray tips.



Quick TeeJet Caps	Quick TeeJet Cap Only		Quick TeeJet Cap & Seat Gasket Set		For Use With Spray Tips
	Part No.	List Price	Part No.	List Price	
	CP25611-*-NY	\$.72	25612-*-NYR	\$1.01	 TeeJet Flat Spray Tips (Smaller Capacities) Standard -0067 Thru -08 XR -01 Thru -08 DG -015 Thru -05 TT -01 Thru -05
	CP25609-*-NY	\$.83	25610-*-NYR	\$1.15	 TeeJet Flat Spray Tips (Larger Capacities) Standard -10 Thru -20 XR -10 Thru -15
	CP25597-*-NY	\$.83	25598-*-NYR	\$1.15	 TJ TwinJet AI 015 Thru 08 No. TJ60...Spray Tip
	CP25599-*-NY	\$.83	25600-*-NYR	\$1.15	 TK-VS FloodJet Turbo FloodJet VisiFlo Spray Tip VisiFlo Spray Tip
	CP25607-*-NY	\$.83	25608-*-NYR	\$1.15	 TK FloodJet FL FullJet TX ConeJet TG Full Cone

Colors of Quick TeeJet Caps	Color Code	Colors of Quick TeeJet Caps	Color Code
Black	1	Green	5
White	2	Yellow	6
Red	3	Brown	7
Blue	4	Orange	8

* Specify color-code (see chart). Unless otherwise specified, a yellow (6) cap will be supplied.

** These Quick TeeJet caps available only in black.

How to order: For a cap and seat gasket set, specify set no. and color-code.

Example: 25612-3-NYR

For cap only, specify part no. and color-code. Ex: CP25597-4-NY

For seat only, specify part no. Ex: CP19438-EPR

	5016157	CP19438-EPR	EPDM Seat & Gasket for cap (Standard)	\$.46
	5016158	CP19438-VI	VITON Seat & Gasket for cap (Optional)	\$2.03

NOZZLES

SPRAY NOZZLE PARTS

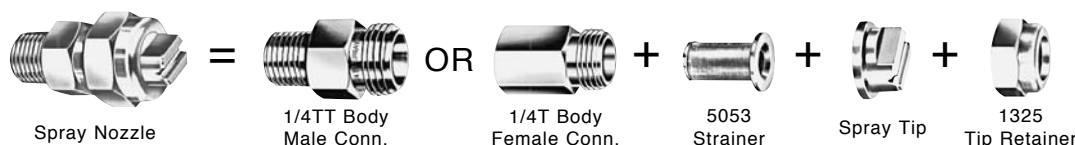



NOZZLE BODIES

TIPS

	Fimco Code No.	Mfg. Part No.	Description	List Price
	5002298	CP1336	1/8 TT Male Brass Body	\$2.18
	5002294	CP1322	1/4 TT Male Brass Body	\$2.18
	5002296	CP8028-NYB	1/4 TT Male Nylon Body	\$1.55
	5002306	CP1335	1/8 T Female Brass Body	\$2.18
	5002302	CP1321	1/4 T Female Brass Body	\$2.18
	5002304	CP12094-NYB	1/4 T Female Nylon Body	\$1.50
	5046022	CP1325	Brass Nozzle Cap	\$1.31
	5046118	CP20230	Brass, For Use With Ceramic Discs and Cores	\$1.57
	5046052	8027	White Nylon Nozzle Cap	\$1.49
	5046126	38027	Black Poly Nozzle Cap	\$0.50
	5046100	CP18032A-NYB	Winged Teejet Nylon Cap	\$1.21
	5005074	4676-1/4	1/4" Brass Adapter (Same thread as nozzle cap)	\$2.73
	5005137	4676-NYB-1/4	1/4" Nylon Adapter (Same thread as nozzle cap)	\$2.23
	5116046	5053-50-SS	Brass Screen Assy w/50 Mesh SS Screen	\$2.76
	5116047	5053-100-SS	Brass Screen Assy w/100 Mesh SS Screen	\$2.76
	5116033	CP2930-50-SS	50 Mesh Stainless Steel Screen Only for 5053	\$0.91
	5116032	CP2930-100-SS	100 Mesh Stainless Steel Screen Only for 5053	\$0.91
	5116019	8079-PP-50	Polypropylene Screen Assy w/50 Mesh SS Screen	\$1.14
	5116020	8079-PP-100	Polypropylene Screen Assy w/100 Mesh SS Screen	\$1.14
	5116112	4514-10	Brass Slotted Strainer 50/Mesh	\$1.29
	5116118	4514-NY-10	Nylon Slotted Strainer 50/Mesh	\$1.21
	5116038	4067-SS-50	Stainless Steel Cup Strainer 50/Mesh	\$1.50
	5116039	4067-SS-100	Stainless Steel Cup Strainer 100/Mesh	\$1.50
	5116040	4193A-5-50SS	Brass Check Valve & Strainer Assy w/50 Mesh Screen	\$4.87
	5116041	4193A-5-100SS	Brass Check Valve & Strainer Assy w/100 Mesh Screen	\$4.87
	5116160	4193A-PP-5-50SS	Poly Check Valve & Strainer Assy w/50 Mesh Screen	\$3.86
	5116164	4193A-PP-5-100SS	Poly Check Valve & Strainer Assy w/100 Mesh Screen	\$3.86
	5143085	11750 -10	Brass Check Valve for Large Capacity Nozzles	\$6.45
	5143187	11750-PP-5	Polypropylene Check Valve for large capacity nozzles	\$5.48

SPLIT-EYELET & SWIVEL SPRAY NOZZLES

	Fimco Code No.	Mfg. Part No.	Description	List Price
	5056042	7421-3/4 T-NYB	Male Split Eyelet Connector, nylon body-fits 3/4" pipe	\$3.80
5056043	7421-1/2 T-NYB	Male Split Eyelet Connector, nylon body-fits 1/2" pipe	\$3.80	

	Fimco Code No.	Mfg. Part No.	Description	List Price
	5056044	7421-3/4 TD	Split Eyelet Nozzle-for Angle Iron Boom-fits 3/4" pipe	\$9.66
5056045	7421-1/2 TD	Split Eyelet Nozzle-for Angle Iron Boom-fits 1/2" pipe	\$9.66	

	Fimco Code No.	Mfg. Part No.	Description	List Price
	5005073	4676-1/8 Brass	Brass Adapter, same thread as Nozzle Cap - Replaces Nozzle Cap to provide 1/8" outlet	\$2.73
	5005074	4676-1/4 Brass	Brass Adapter, same thread as Nozzle Cap - Replaces Nozzle Cap to provide 1/4" outlet	\$2.73
5005137	4676- NYB-1/4	Nylon Adapter, same thread as Nozzle Cap - Replaces Nozzle Cap to provide 1/4" outlet	\$2.23	

	Fimco Code No.	Mfg. Part No.	Description	List Price
	5002382	5000-1/4T	Body assy for Swivel, less tip, cap & strainer, brass	\$17.38

	Fimco Code No.	Mfg. Part No.	Description	List Price
	5002383	5540-1/4TT	Body assy for Swivel, less tip, cap & strainer, brass	\$19.22

	Fimco Code No.	Mfg. Part No.	Description	List Price
	5002385	6240-1/4TT	Body assy for Swivel, less tip, cap & strainer, brass	\$18.82

	Fimco Code No.	Mfg. Part No.	Description	List Price
	5002386	7450-2T	Body assy for Swivel, less tip, cap & strainer, brass	\$31.74

	Fimco Code No.	Mfg. Part No.	Description	List Price
	5143201	20900-1/4MXT	1/4M Brass Valve & Nozzle Body	\$56.91
5143202	20900-1/4FXT	1/4F Brass Valve & Nozzle Body	\$56.91	
		A compact quarter turn "On-Off " ball valve used with interchangeable spray tips. Brass construction. Maximum operating pressure - 400 P.S.I.		